

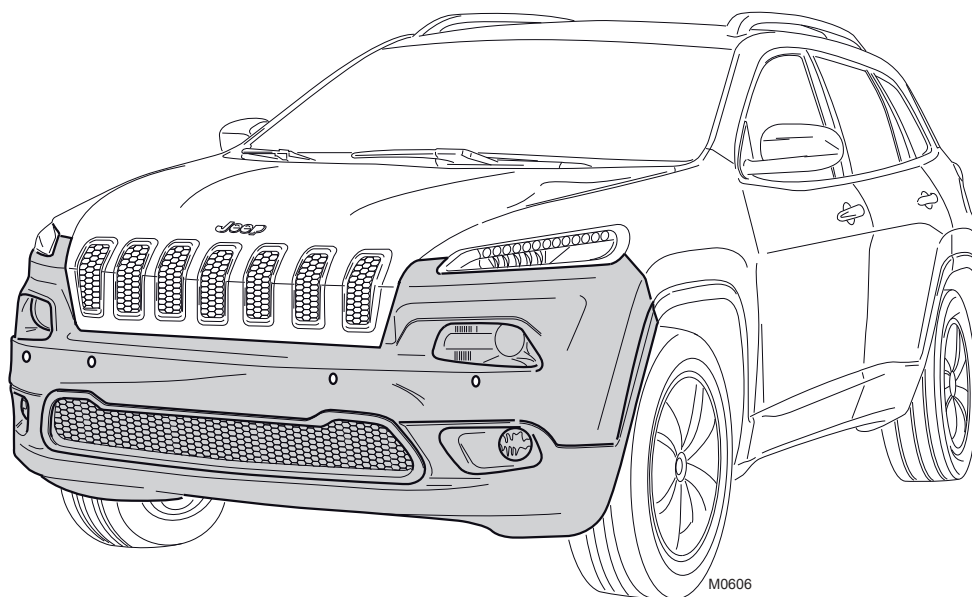

# JEEP Cherokee (KL) Parking Aid - Front



**EN**

**PARKING AID - FRONT**  
Installation Instruction

**DE**

**EINPARKHILFE - VORNE**  
Einbauanleitung

**ES**

**CONTROL DE DISTANCIA PARA APARCAR - AL FRENTE**  
Instrucciones de montaje

**FR**

**ASSISTANCE DE RANGEMENT - À L'AVANT**  
Instructions de montage

**IT**

**COLLIMATORE D'AIUTO PARCHEGGIO - AVANTI**  
Istruzioni di montaggio

Part Number: 82213928

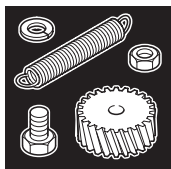

© Copyright 2012

<http://www.dealers-mopar.com/international-accessory-catalog/>

Subject to alteration without notice,  
for latest status check internet site  
Technische Änderungen vorbehalten  
Reservadas modificaciones técnicas  
Sous réserve de modifications techniques  
Con riserva di apportare modifiche tecniche

Expert Fitment Required  
Montage durch Fachwerkstatt erforderlich  
Montaje sólo por el concesionario  
Montage par spécialiste nécessaire  
E' necessario in officina specializzata

05-2013

**K6861798**

© CHRYSLER

**EN****Important Information**

- Expert Fitment Required.
- Disconnect the battery earth cable.
- To be painted to MOPAR Service Specification.
- Install parts as shown on illustrations.
- When installing, avoid contact of the sensor heads with metal objects.
- The correct sensor fitting direction is with the point marking positioned up (the point marking is on the sensor head installation bushing).
- Ensure that the wire harness is routed and fixed in the correct position.
- To avoid damage to the wiring harness, ensure contact with sharp edges is prevented.
- Re-fit panels, ensure that the wiring harness and other components are neatly and securely located.
- Re-connect battery.

**ES****Información importante**

- Montaje sólo por el concesionario.
- Desconectar el cable de masa de la batería.
- Lacado según las Instrucciones de Servicio MOPAR.
- Montar las piezas tal como se indica en las figuras.
- Durante la instalación, evitar el contacto de la cabeza de los sensores con objetos metálicos.
- La correcta dirección de montaje del sensor es cuando el punto de posicionamiento está hacia arriba (el punto de posicionamiento se encuentra en la parte delantera de la cabeza del sensor).
- Preste atención a que el mazo de cables transcurra por el lugar correcto y esté fijado correctamente.
- A efectos de evitar desperfectos en el aislamiento del cable, hay que evitar el contacto con aristas cortantes.
- Volver a colocar los paneles; preste atención a que el mazo del cable y las demás piezas tengan la posición correcta y precisa.
- Conectar de nuevo la batería y verificar el funcionamiento control de distancia para apar

**IT****Informazioni importanti**

- Il montaggio deve essere effettuato da un'officina specializzata.
- Staccare il cavo di massa dalla batteria.
- Verniciatura secondo le prescrizioni di servizio de MOPAR.
- Montare le parti secondo quanto rilevabile dalle illustrazioni.
- Durante l'installazione evitare di urtare i sensori con corpi metallici.
- La corretta posizione di installazione è quella col punto di riferimento sul fronte sensore verso l'alto (la marcatura è sulla ghiera frontale del sensore).







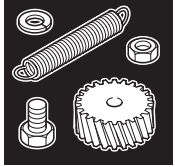
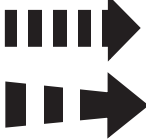

**DE****Wichtige Information**

- Montage durch Fachwerkstatt erforderlich.
- Massekabel von Batterie abklemmen.
- Lackierung gemäß MOPAR Service Vorschriften.
- Teile gemäß Abbildung montieren.
- Vermeiden Sie beim Einbau den Kontakt der Sensor-Köpfe mit Metallgegenständen.
- Der korrekte Einbau der Sensoren erfolgt, indem die Markierung auf der Sensor-Kopf Seite in der oberen Position ist.
- Achten Sie darauf, daß der Kabelbaum an der richtigen Stelle verläuft und ordnungsgemäß befestigt ist.
- Zur Vermeidung von Beschädigungen an der Kabelisolation ist Berührung mit scharfen Kanten zu vermeiden.
- Paneele wieder anbringen; achten Sie darauf, daß der Kabelbaum und andere Teile ordnungsgemäß und genau positioniert sind.
- Batterie wieder anschließen und Funktion der Einparkhilfe überprüfen.

**FR****Informations importantes**

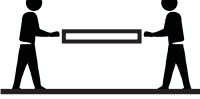
- Le montage doit être effectué par un spécialiste.
- Débrancher le câble de masse de la batterie.
- Peinture conformément aux Directives de Service de MOPAR.
- Monter les pièces selon les figures.
- Lors de l'installation, évitez le contact des têtes de sonde avec des objets en métal.
- L'orientation correcte de la sonde lors de l'installation est repérée avec l'emprunte du point en position haute (le point se trouve sur la face extérieure de la tête de la sonde).
- Veiller à ce que le faisceau de câbles passe au bon endroit et soit correctement fixé.
- Éviter tout contact avec des arêtes vives afin de ne pas endommager l'isolation des câbles.
- Remettre les panneaux; veillez à ce que le faisceau et les autres pièces soient positionnés correctement et avec la précision requise.
- Rebrancher la batterie et contrôler le fonctionnement de l'aide au stationnement.

- Fate attenzione, che il fascio di cavi sia posato al posto giusto e fissato a regola d'arte.
- Allo scopo di evitare danni all'isolazione dei cavi, evitare di metterli a contatto con spigoli acuti.
- Rimettere in posizione i pannelli; far ben attenzione che il fascio di cavi e le altre partiziano state posizionate con esattezza e nella dovuta maniera.
- Ricollegare la batteria e controllare le funzioni del sistema di parcheggio.

<p><b>A</b> <b>1x</b></p> <ul style="list-style-type: none"> <li>(EN) Kit parts with quantity</li> <li>(DE) Kitteile mit Anzahl</li> <li>(ES) Piezas del kit y cantidad</li> <li>(FR) Element de kit et quantité</li> <li>(IT) Componenti del Kit e quantità</li> </ul> <p>M0086</p>	<p><b>1</b></p> <ul style="list-style-type: none"> <li>(EN) Fitting Step</li> <li>(DE) Einbauschritt</li> <li>(ES) Número de paso</li> <li>(FR) Etape</li> <li>(IT) Operazione di adattamento</li> </ul> <p>M0087</p>	<p><b>1</b></p> <ul style="list-style-type: none"> <li>(EN) Step within fitting step</li> <li>(DE) Schritt innerhalb des Einbauschritts</li> <li>(ES) Orden de instrucción dentro de la operación de montaje</li> <li>(FR) Etape dans le déroulement des étapes</li> <li>(IT) Istruzione parziale dell'operazione di adattamento</li> </ul> <p>M0088</p>
 <ul style="list-style-type: none"> <li>(EN) Spare parts</li> <li>(DE) Ersatzteile</li> <li>(ES) Piezas de repuesto</li> <li>(FR) Pièces de rechange</li> <li>(IT) Pezzi di ricambio</li> </ul> <p>M0089</p>	 <ul style="list-style-type: none"> <li>(EN) Movement Arrow</li> <li>(DE) Bewegungspfeil</li> <li>(ES) Flecha de movimiento</li> <li>(FR) Flèche indiquant le sens du mouvement</li> <li>(IT) Freccia di movimento</li> </ul> <p>M0090</p>	 <ul style="list-style-type: none"> <li>(EN) Location/Position Arrow</li> <li>(DE) Positionspfeil</li> <li>(ES) Flecha de posición</li> <li>(FR) Flèche de Position</li> <li>(IT) Freccia di posizione</li> </ul> <p>M0091</p>
 <ul style="list-style-type: none"> <li>(EN) Warning</li> <li>(DE) Achtung</li> <li>(ES) Atención</li> <li>(FR) Attention</li> <li>(IT) Attenzione</li> </ul> <p>M0092</p>	 <ul style="list-style-type: none"> <li>(EN) See Workshop Manual</li> <li>(DE) Siehe Werkstatthandbuch</li> <li>(ES) Ver manual de taller</li> <li>(FR) Voir Manuel d'atelier</li> <li>(IT) Vedere manuale officina</li> </ul> <p>M0093</p>	 <ul style="list-style-type: none"> <li>(EN) Refer to specific view</li> <li>(DE) Siehe Abbildung</li> <li>(ES) Ver figura</li> <li>(FR) Cf. figure</li> <li>(IT) Vedi figura</li> </ul> <p>M0094</p>
<p><b>BK</b></p> <ul style="list-style-type: none"> <li>(EN) Wire color reference</li> <li>(DE) Farbreferenz</li> <li>(ES) Referencia al color del cable</li> <li>(FR) Référence de couleur de cable</li> <li>(IT) Riferimenti colori cavi</li> </ul> <p>M0095</p>	<p><b>X1</b></p> <ul style="list-style-type: none"> <li>(EN) Vehicle O.E. Part</li> <li>(DE) Fahrzeug O.E. Teile</li> <li>(ES) Pieza original del vehículo</li> <li>(FR) Pièce d'origine de véhicule</li> <li>(IT) Pezzo originale del veicolo</li> </ul> <p>M0096</p>	 <ul style="list-style-type: none"> <li>(EN) 2 Man Operation Required</li> <li>(DE) Nur zu zweit ausführen</li> <li>(ES) Realizar sólo entre dos personas</li> <li>(FR) 2 personnes nécessaire pour l'opération</li> <li>(IT) Da eseguire soltanto in due</li> </ul> <p>M0097</p>
 <ul style="list-style-type: none"> <li>(EN) Left Hand drive Vehicle</li> <li>(DE) Linksgelenktes Fahrzeug</li> <li>(ES) Volante a la izquierda</li> <li>(FR) Véhicule direction à gauche</li> <li>(IT) Veicolo con guida a sinistra</li> </ul> <p>M0098</p>	 <ul style="list-style-type: none"> <li>(EN) Correct</li> <li>(DE) Richtig</li> <li>(ES) Correcto</li> <li>(FR) Correct</li> <li>(IT) Corretto</li> </ul> <p>M0101</p>	 <ul style="list-style-type: none"> <li>(EN) Incorrect</li> <li>(DE) Falsch</li> <li>(ES) Incorrecto</li> <li>(FR) Incorrect</li> <li>(IT) Scorretto</li> </ul> <p>M0102</p>

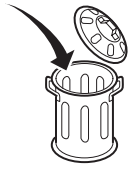

- (EN) Throw away
- (DE) Entsorgen
- (ES) Tirar a la basura
- (FR) Jeter aux déchets
- (IT) Smaltire

M0103



- (EN) Disconnect
- (DE) Abziehen
- (ES) Desconectar
- (FR) Déconnecter
- (IT) Scollegare

M0312



- (EN) Connect
- (DE) Verbinden
- (ES) Conectar
- (FR) Connecter
- (IT) Collegare

M0105



**CLEANER**

- (EN) Degrease
- (DE) Entfetten
- (ES) Desengrasar
- (FR) Dégraisser
- (IT) Sgrassare

M0106



# JEEP Cherokee (KL) PARK PILOT

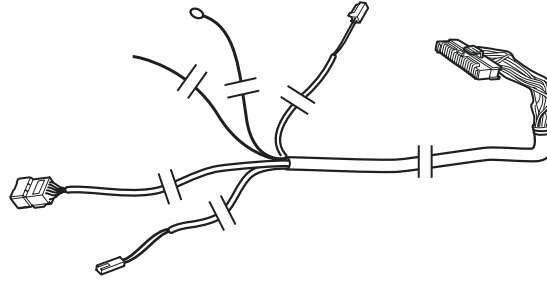

**A** 1x

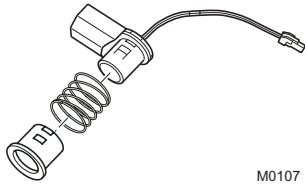

**B** 4x

M0107

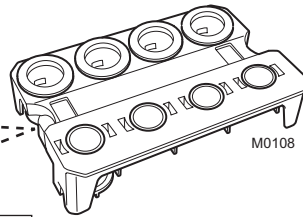

1x

M0108

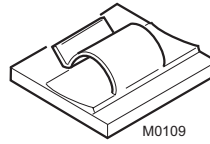

**C** 5x

M0109

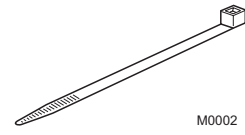

**D** 30x

M0002

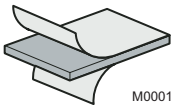

**E** 1x

M0001

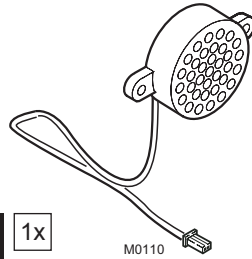

**F** 1x

M0110

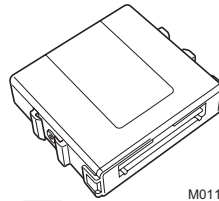

**G** 1x

M0111

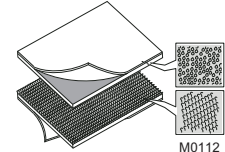

**H** 1x

M0112



**I** 2x

M0012

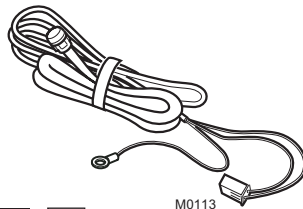

**J** 1x

M0113

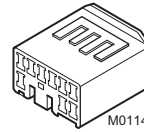

**K** 1x

M0114

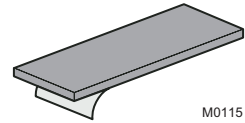

**L** 6x

M0115

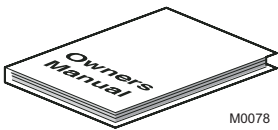

**M** 1x

M0078

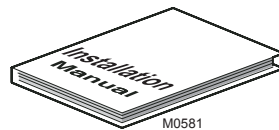

**O** 1x

M0581

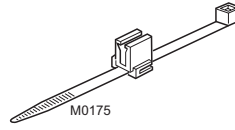

**P** 4x

M0175

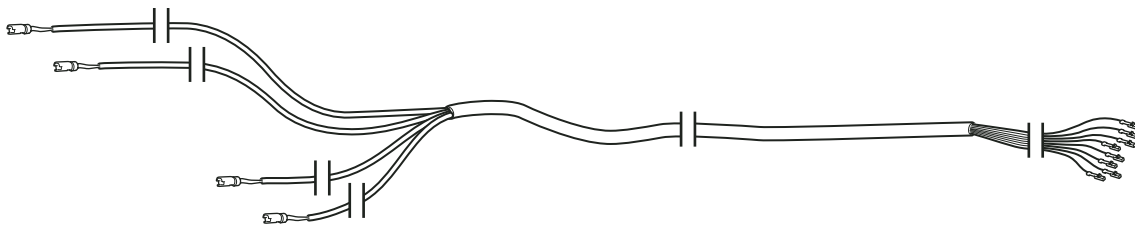

**Z** 1x

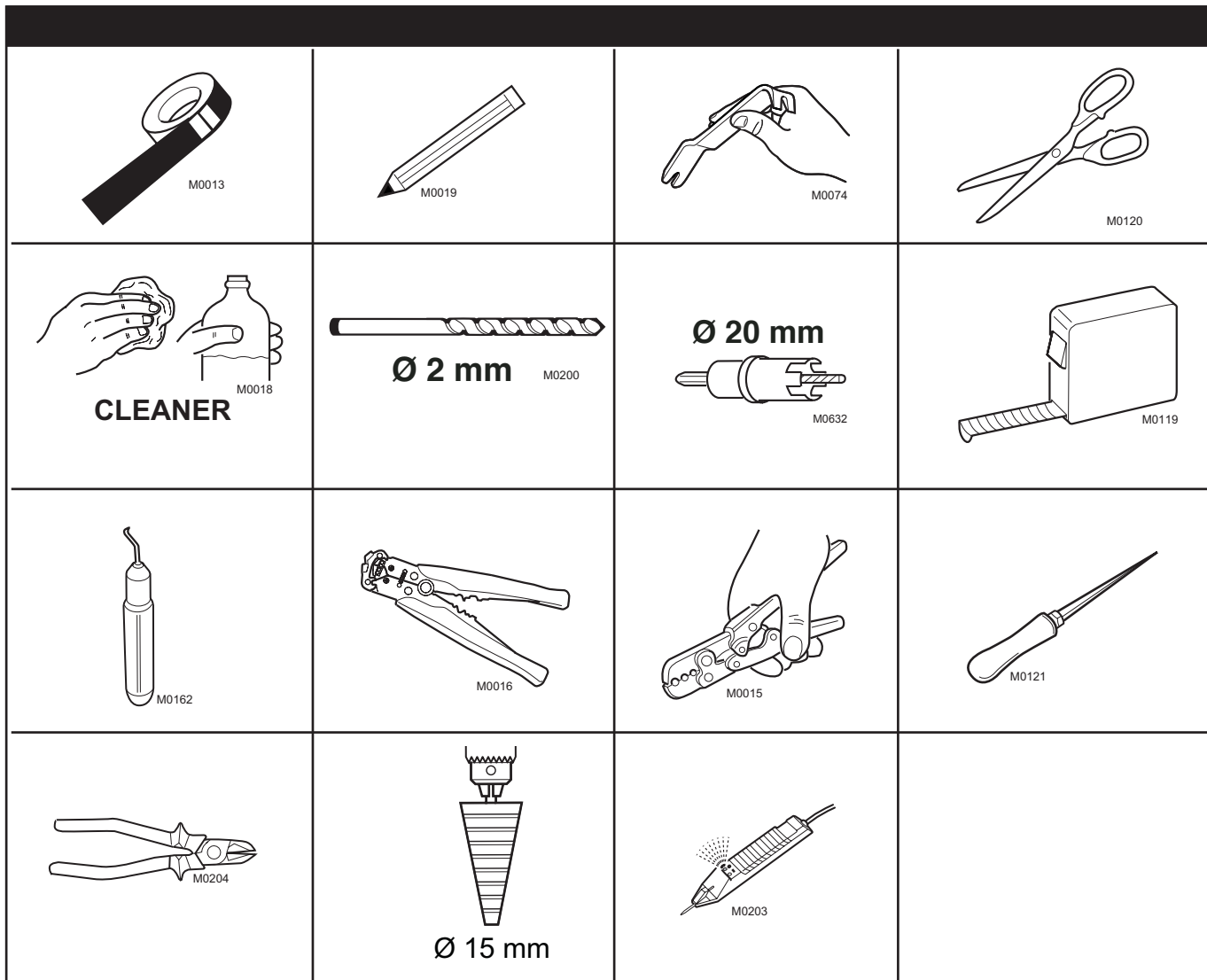

	GB	D	E	F	I
BK	Black	Schwarz	Negro	Noir	Nero
RD	Red	Rot	Rojo	Rouge	Rosso
GN	Green	Grün	Verde	Vert	Verde
OR	Orange	Orange	Naranja	Orange	Arancione
VT	Violet	Violett	Violeta	Violet	Viola
PK	Pink	Pink	Pink	Rose	Rosa
BL	Blue	Blau	Azul	Bleu	Blu
YL	Yellow	Gelb	Amarillo	Jaune	Giallo
WH	White	Weiß	Blanco	Blanc	Bianco
BR	Brown	Braun	Marrón	Brun	Marrone
GY	Grey	Grau	Gris	Gris	Grigio
LG	Light green	Hellgrün	Verde claro	Vert clair	Verde chiaro

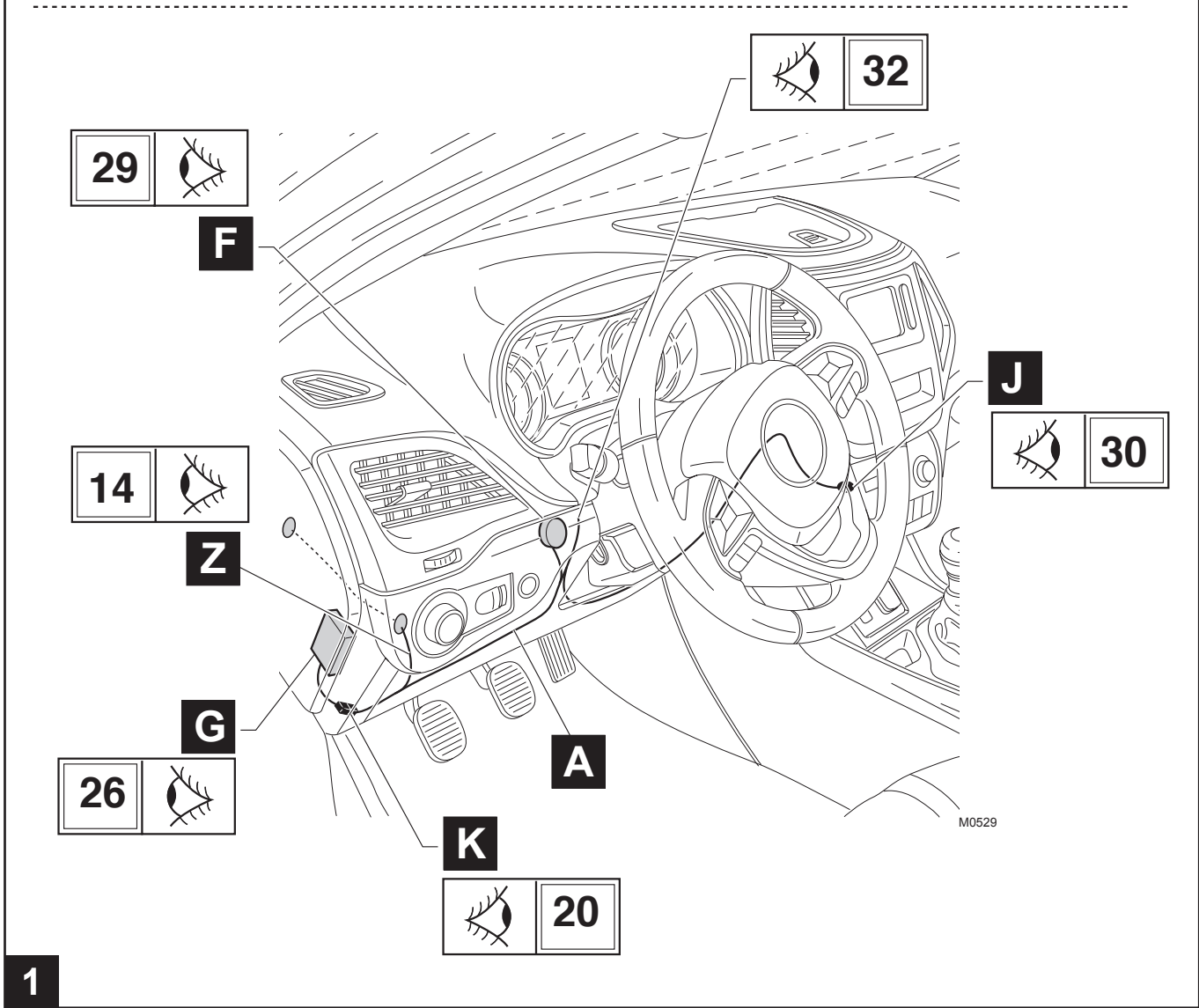
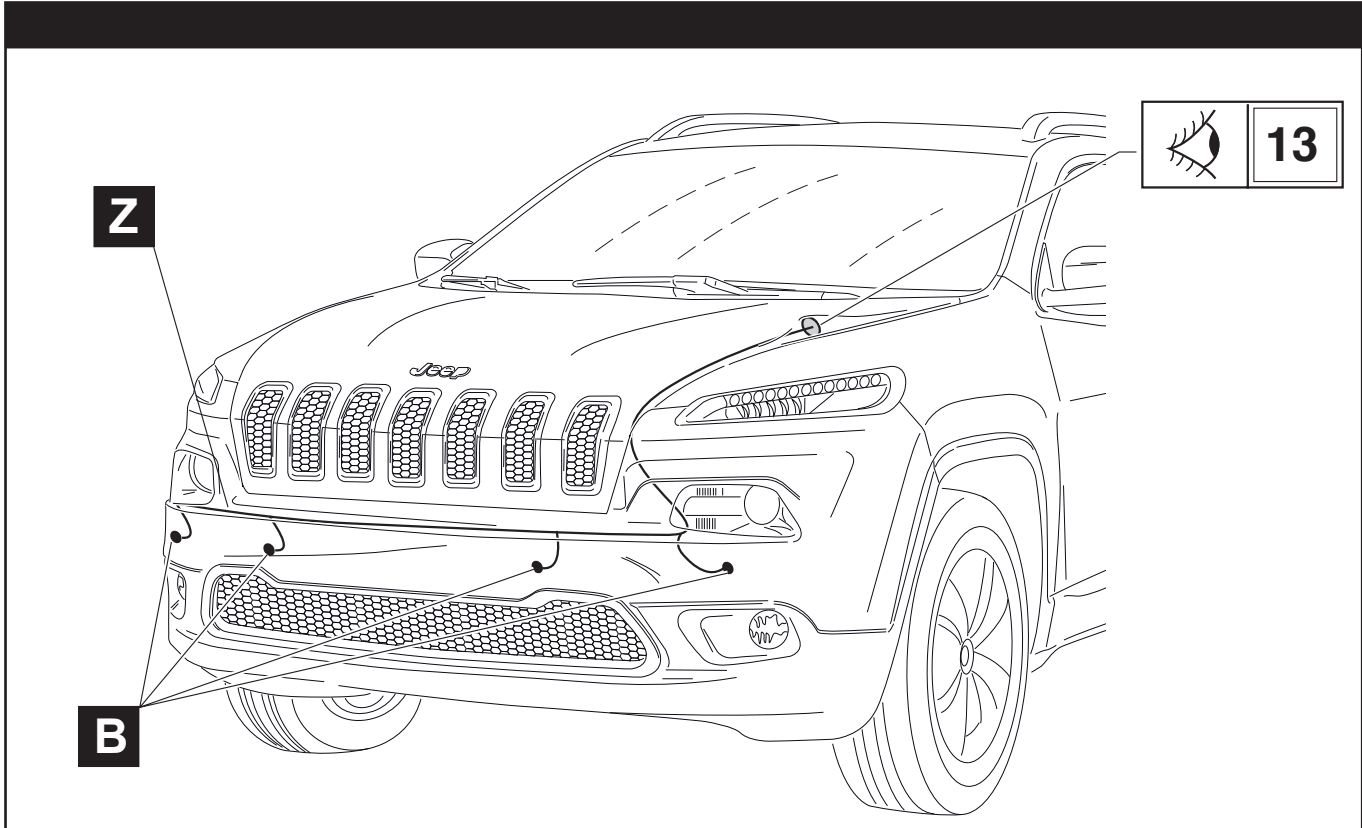

**1**

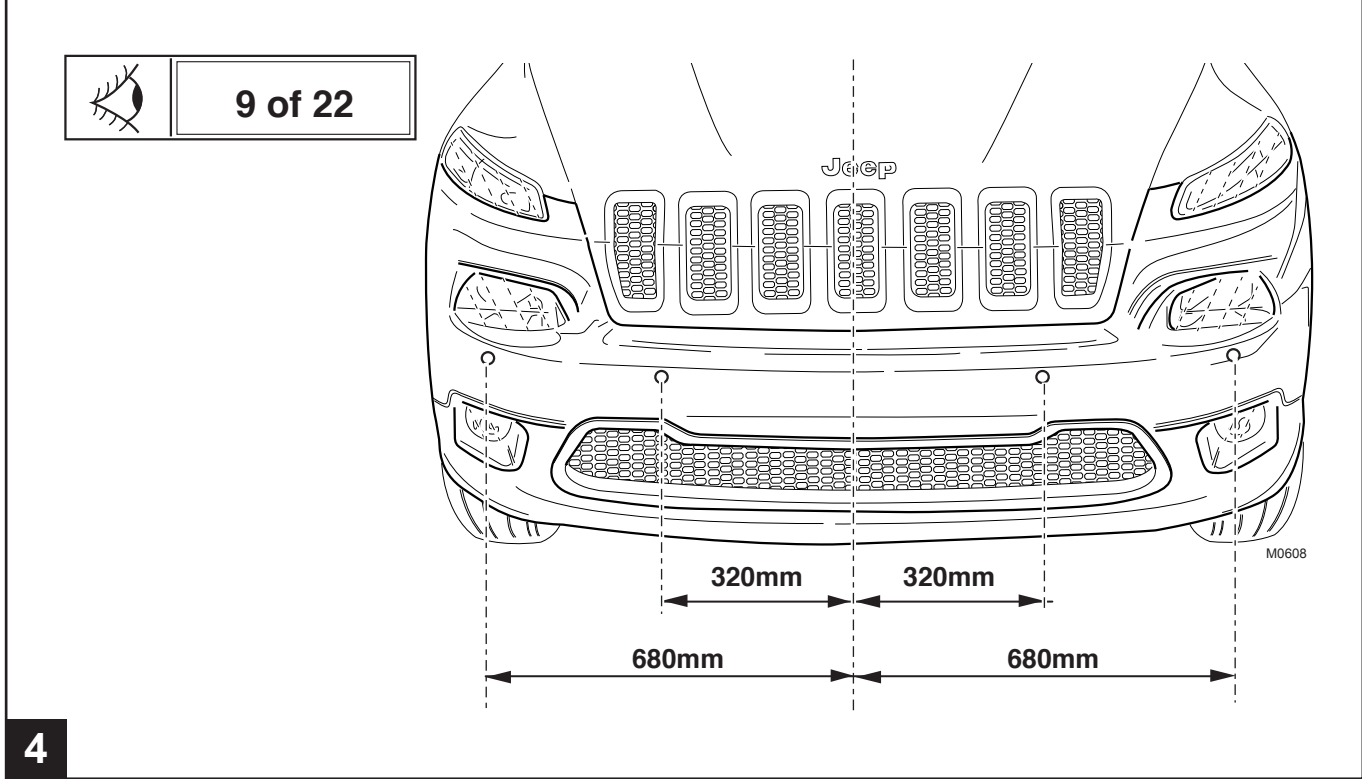
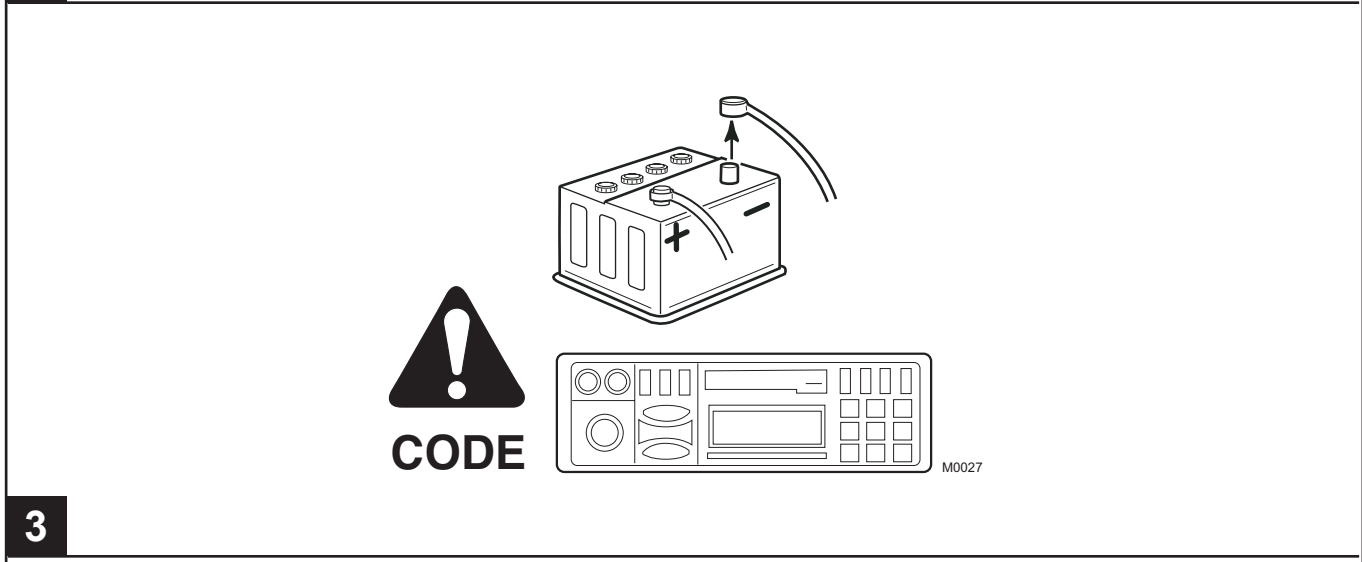
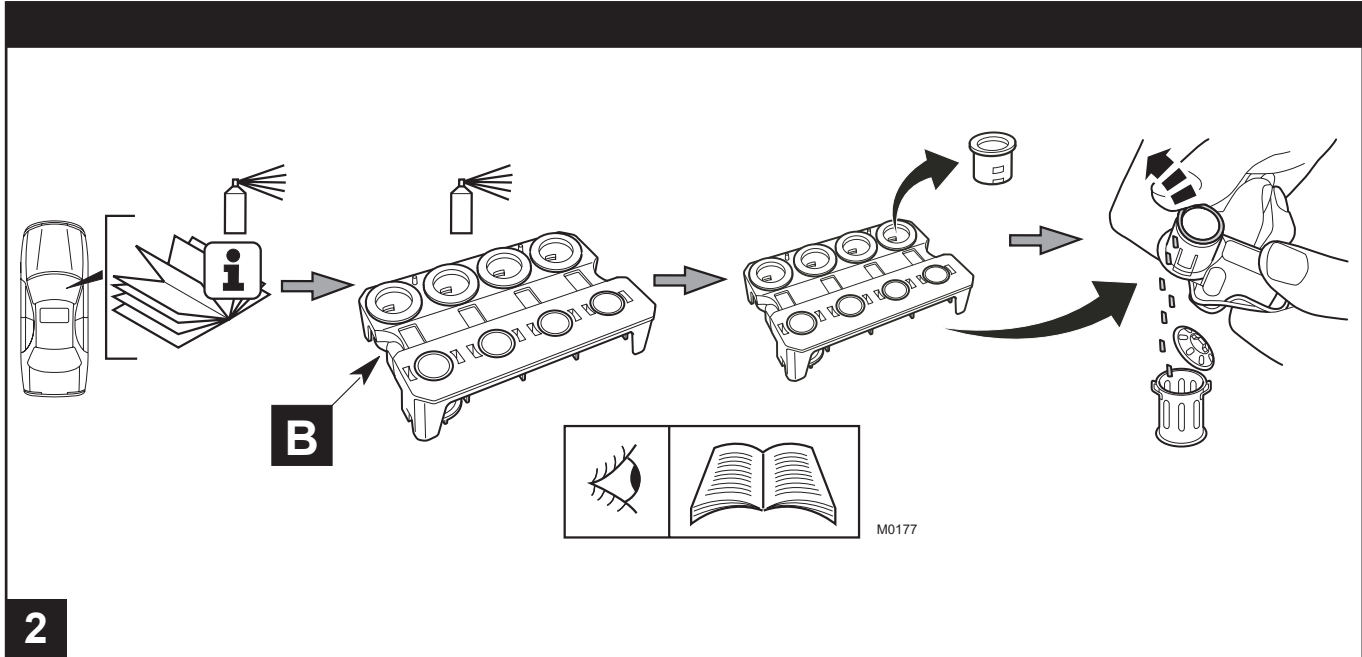



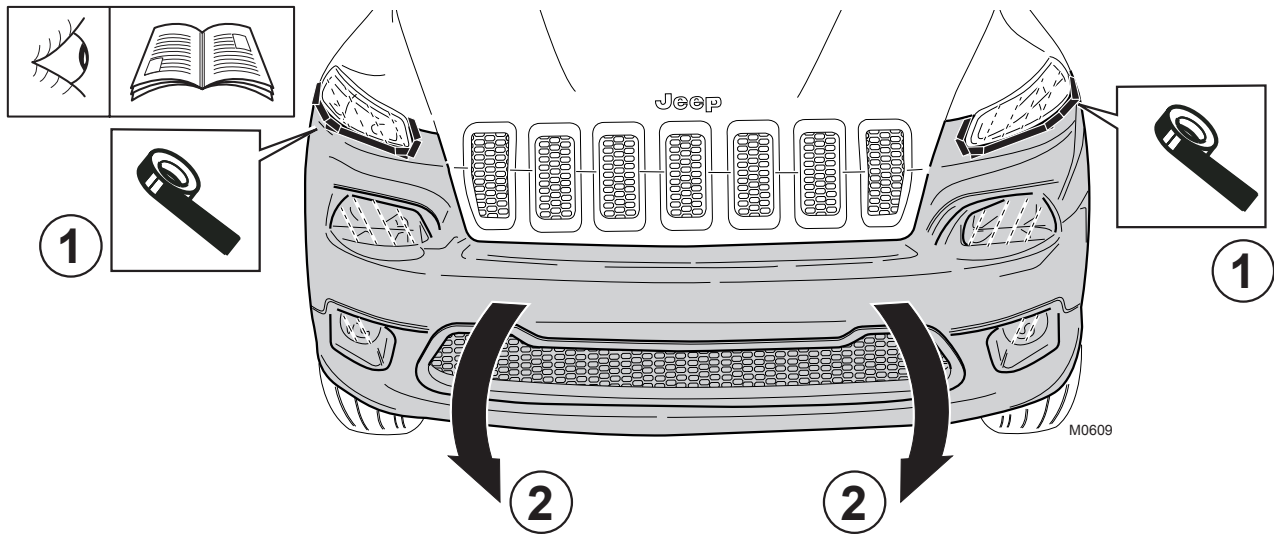

5

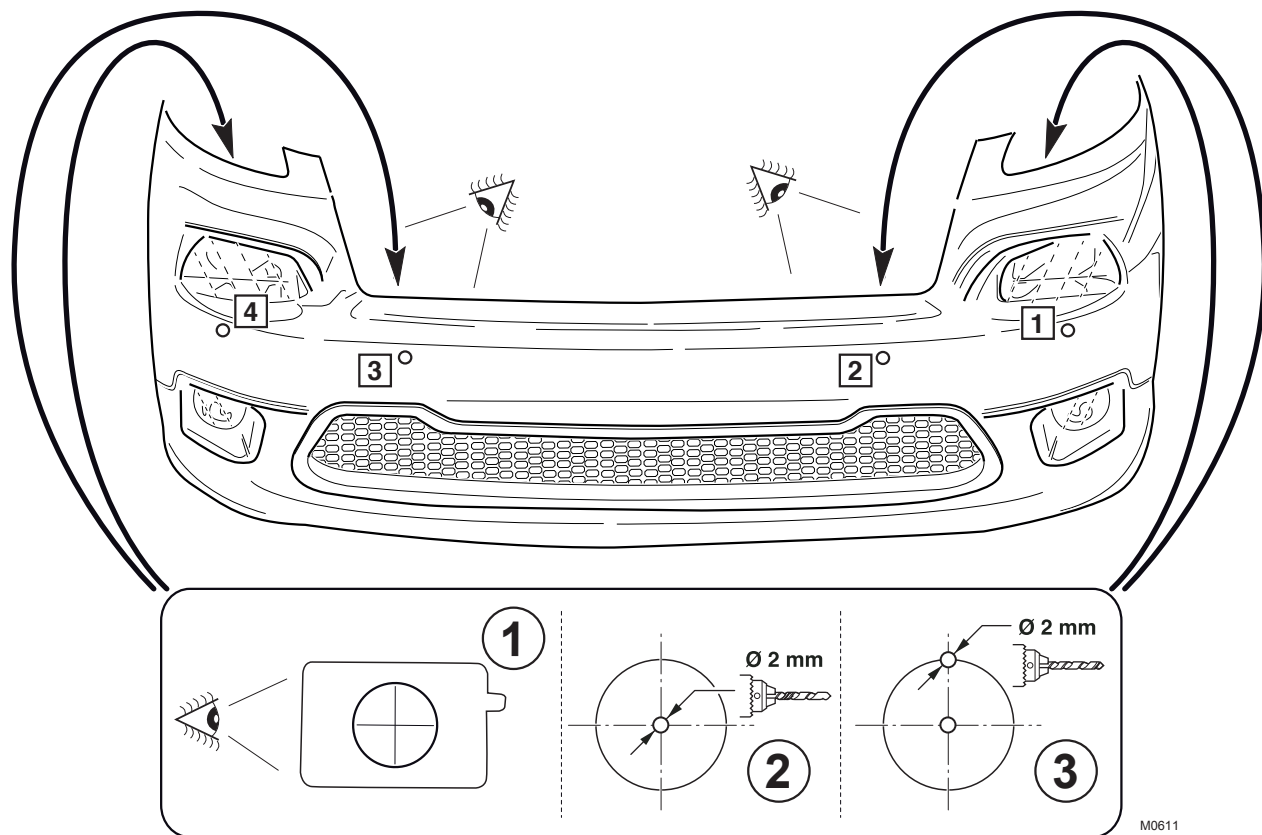

6

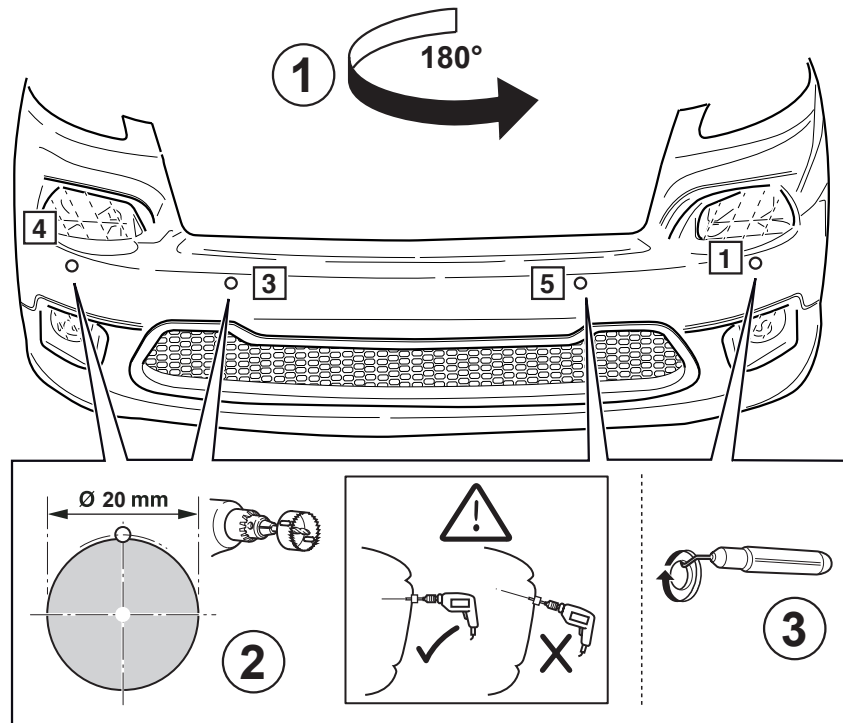

7

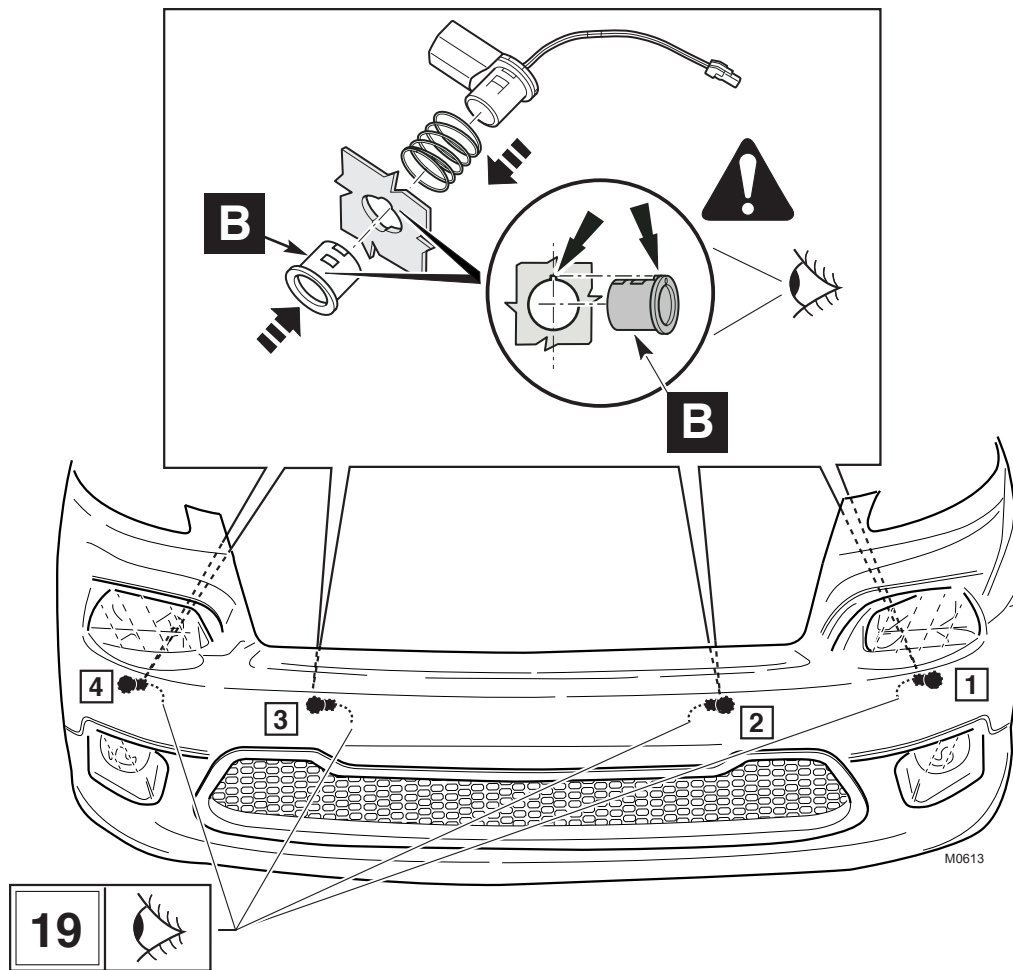

8



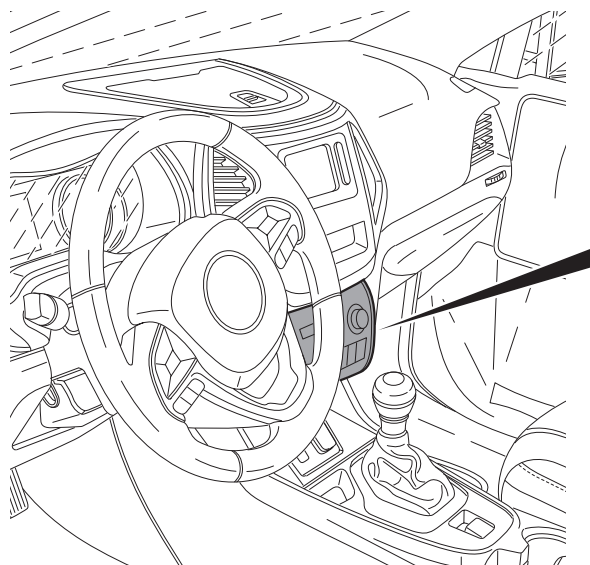
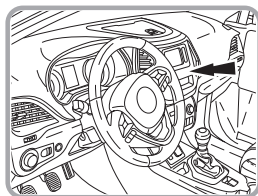
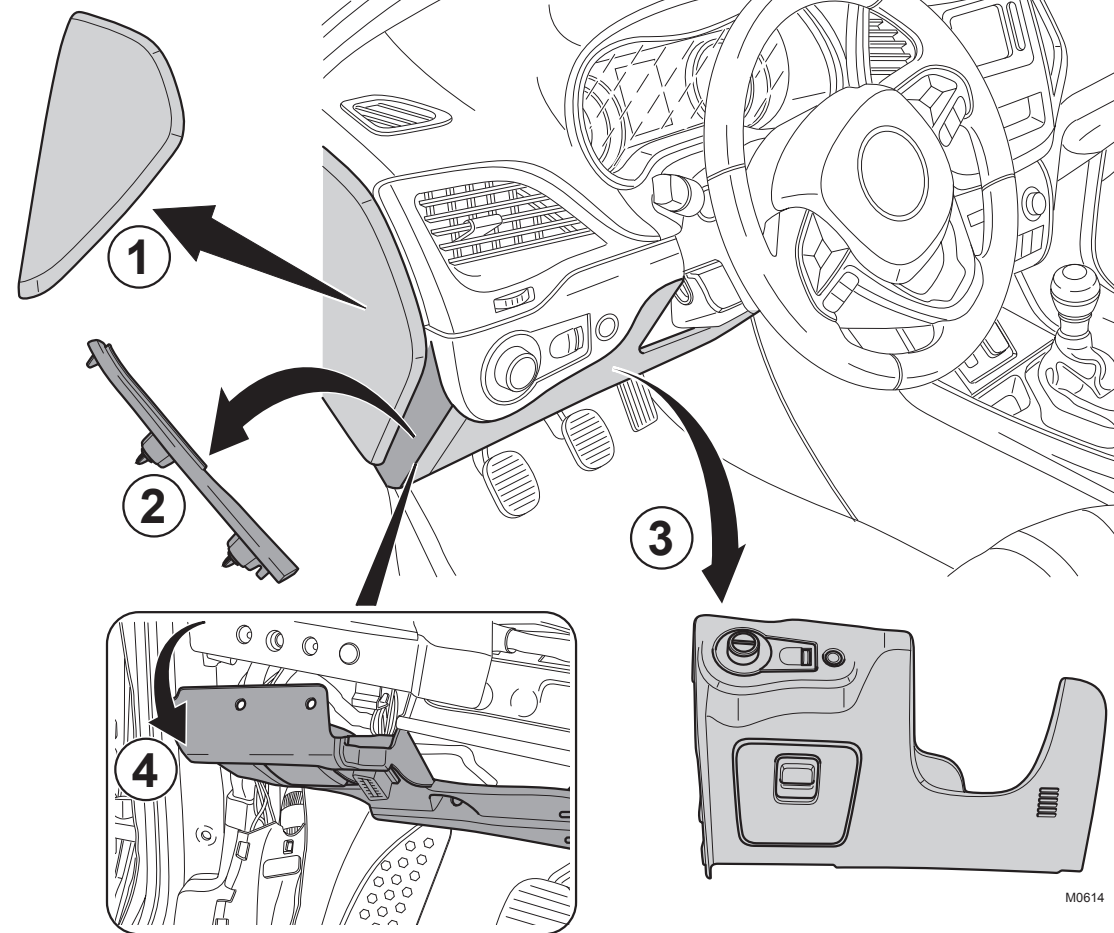
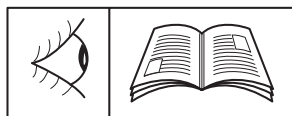

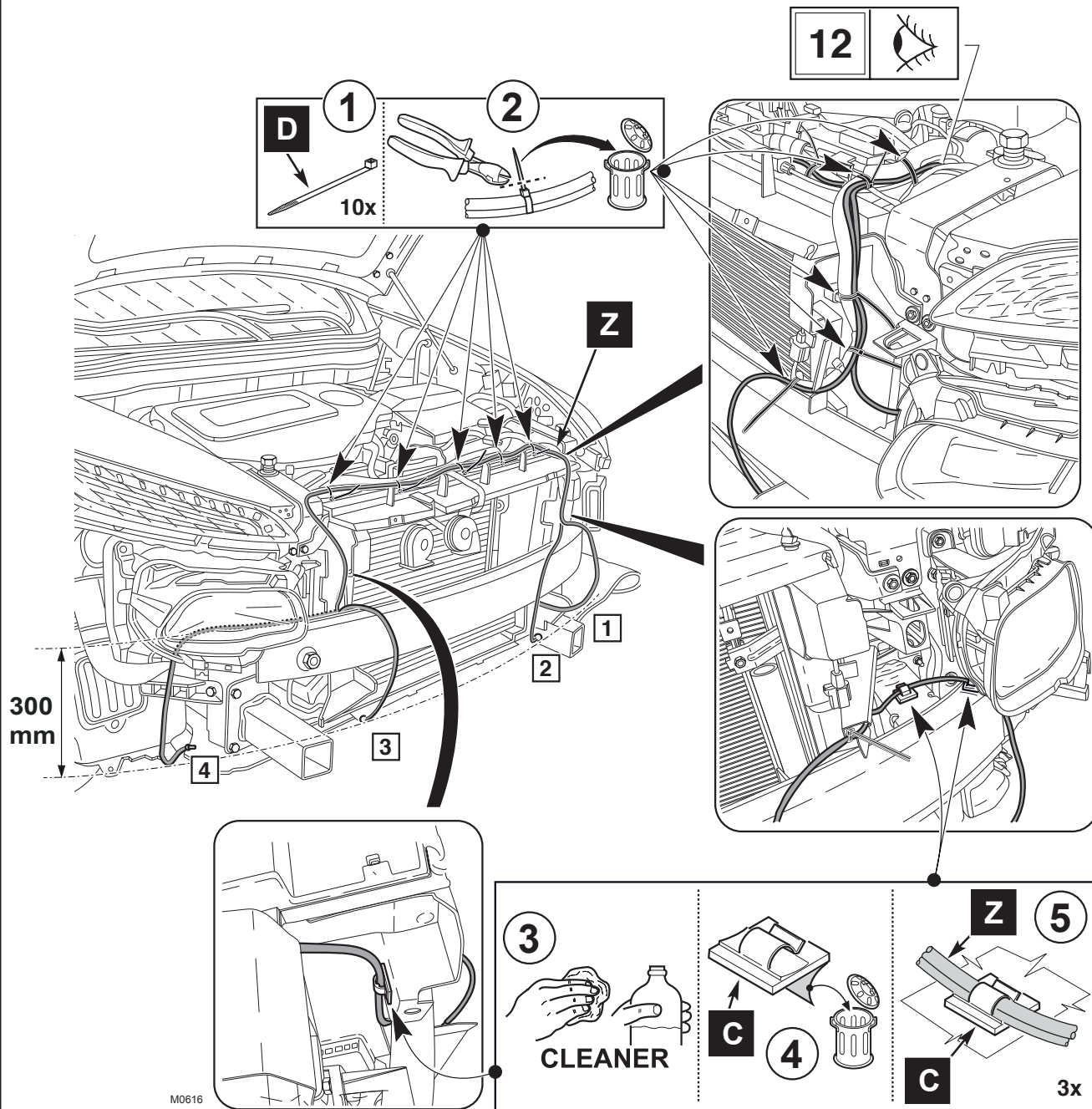

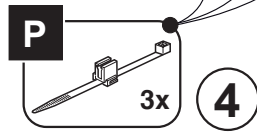
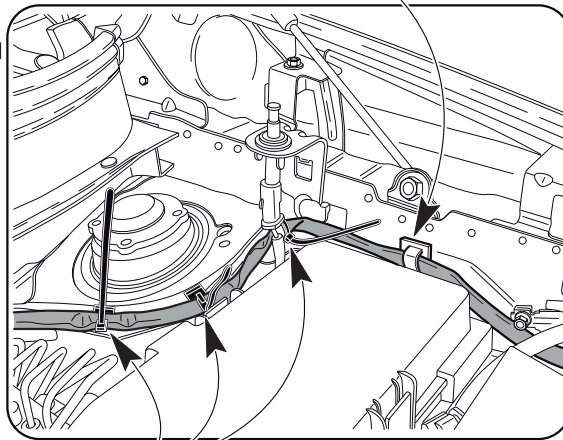
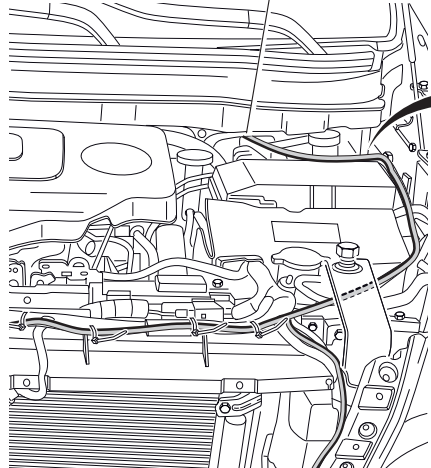
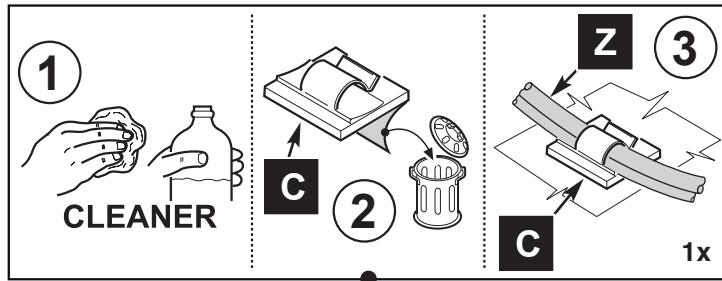
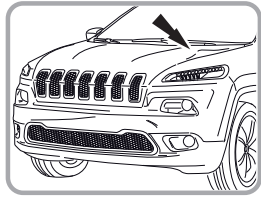

M0617

12

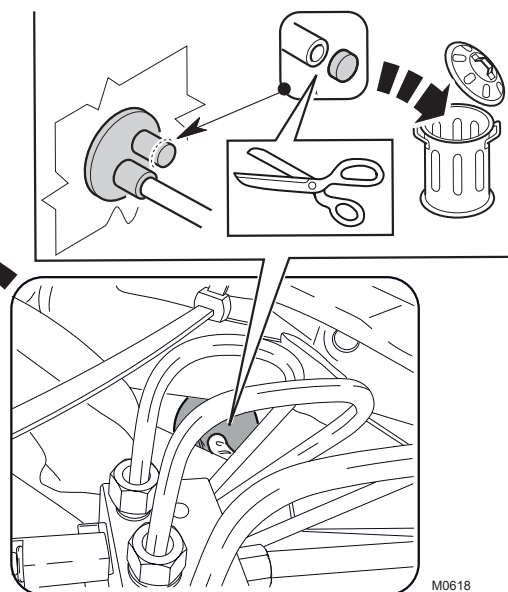
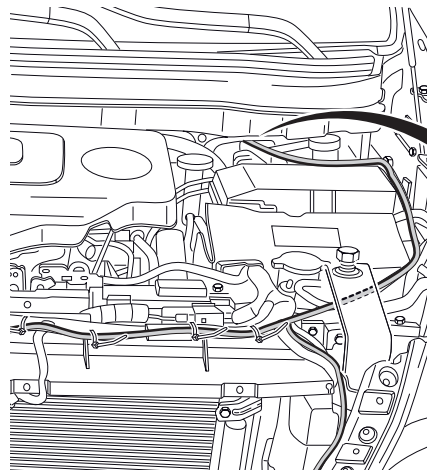

M0618

13

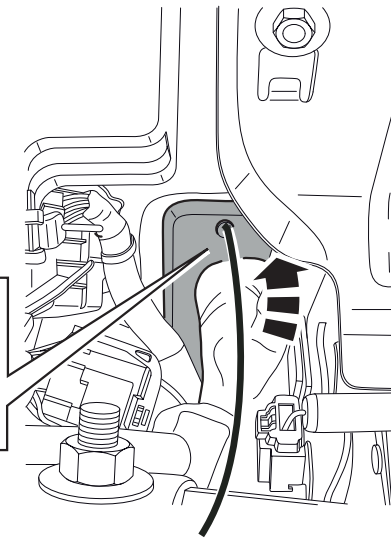
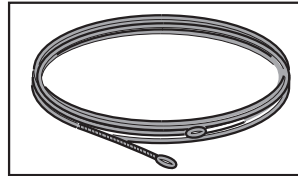
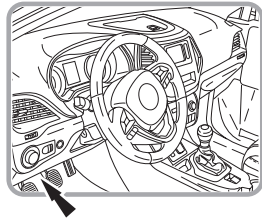

M0619

14

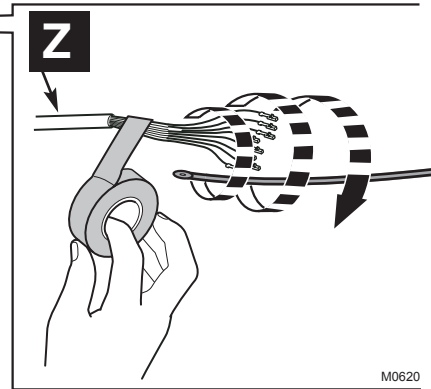
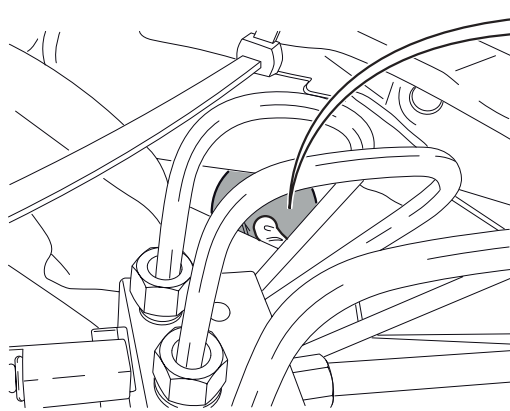
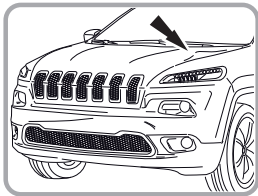

M0620

15

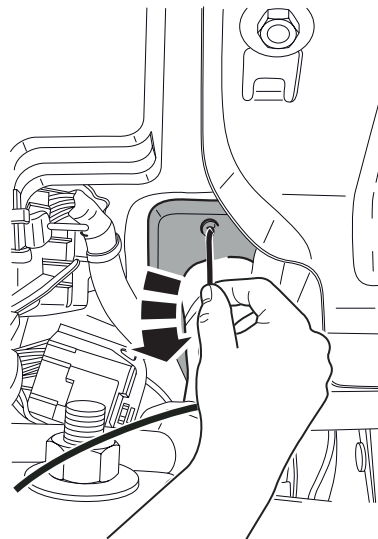
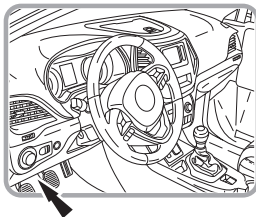

M0621

16

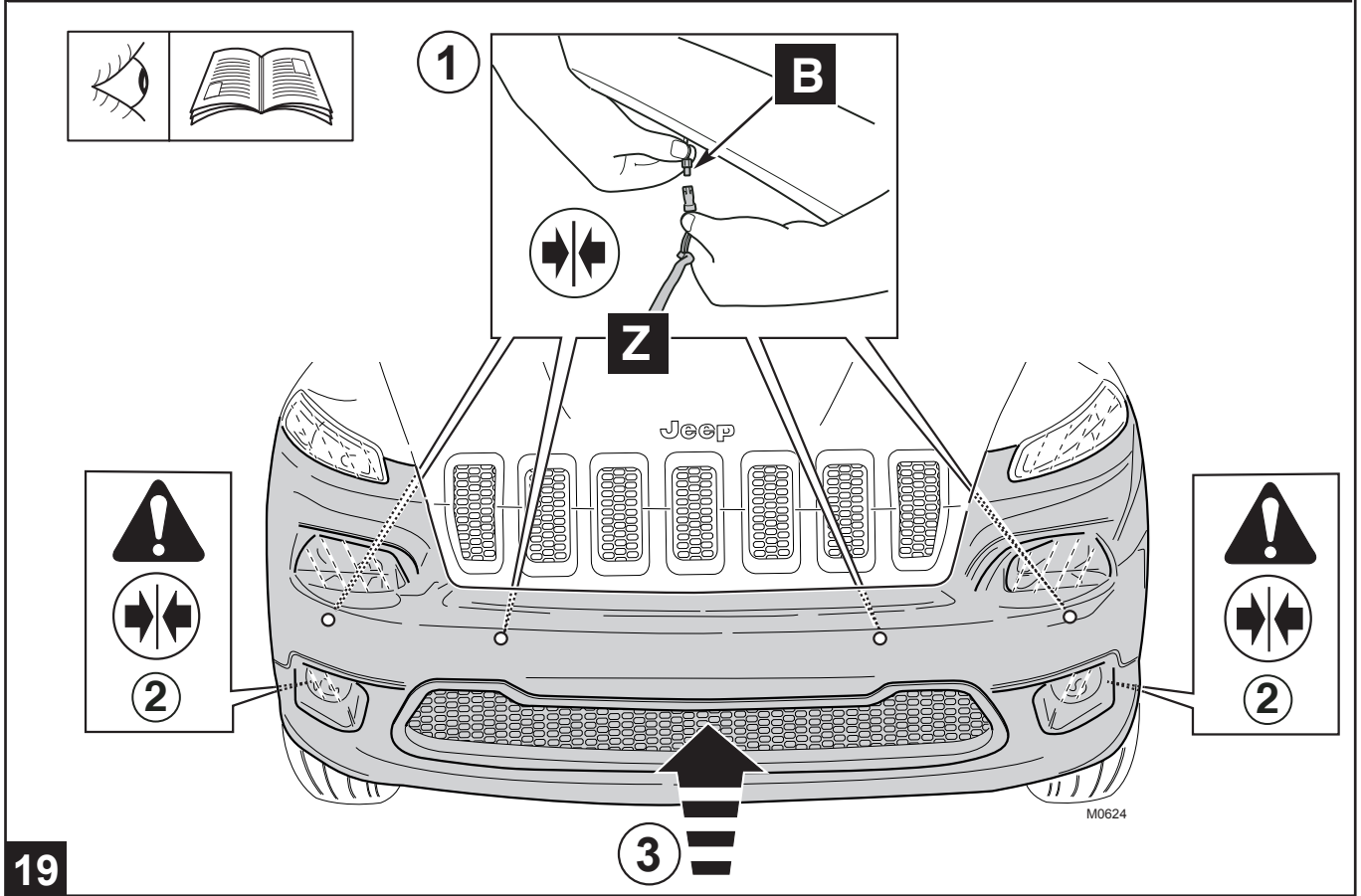
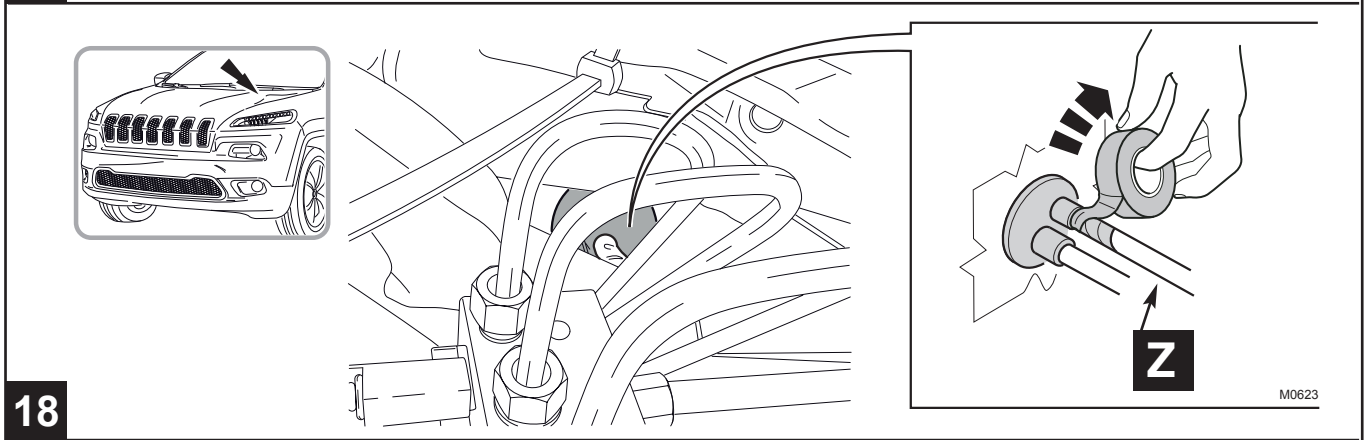
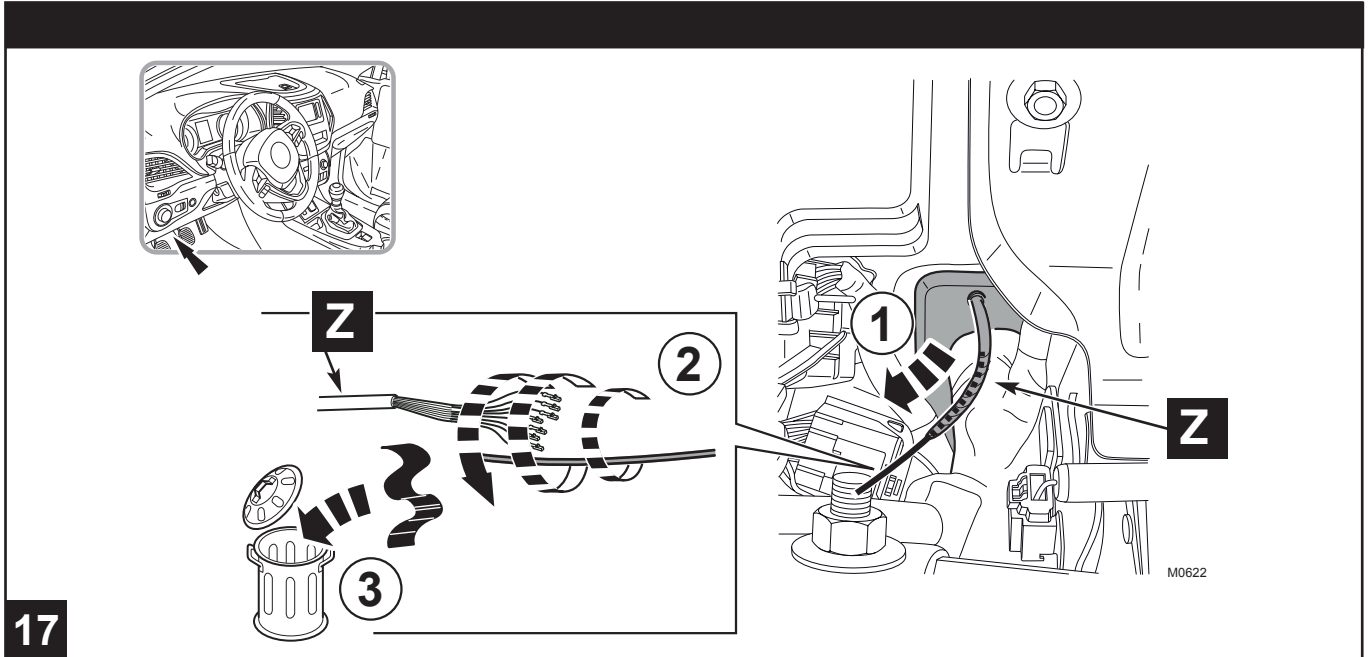

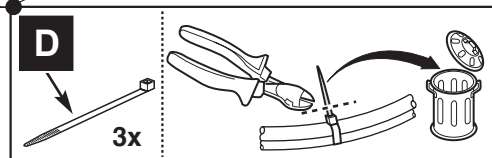
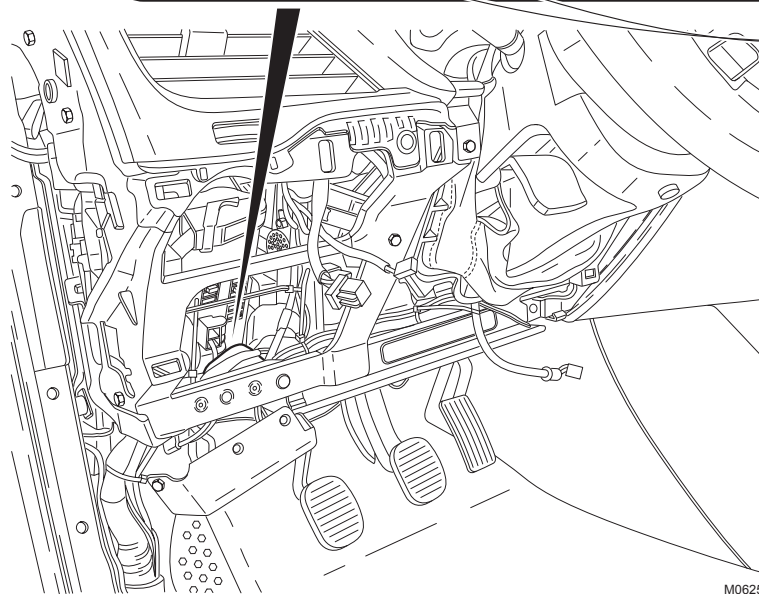
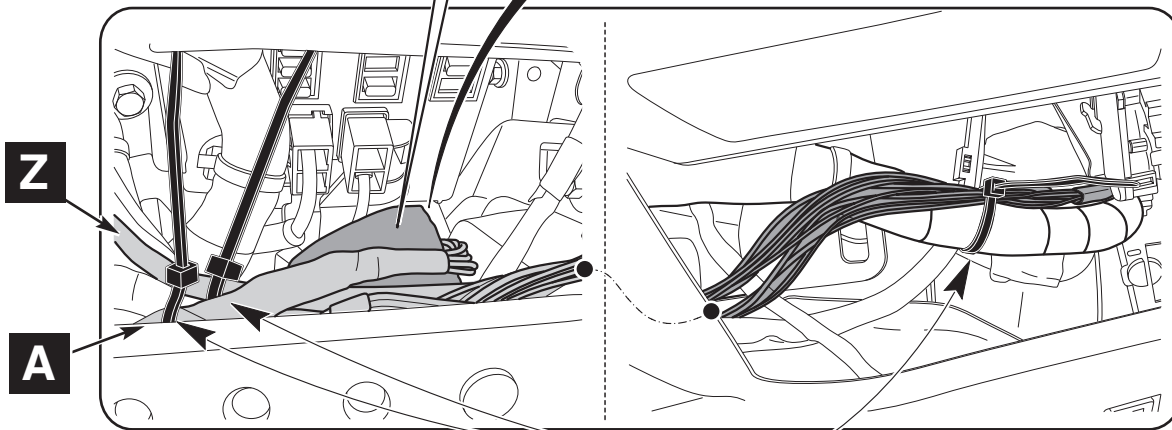
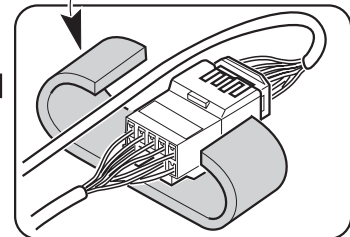
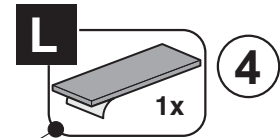
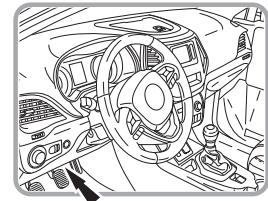
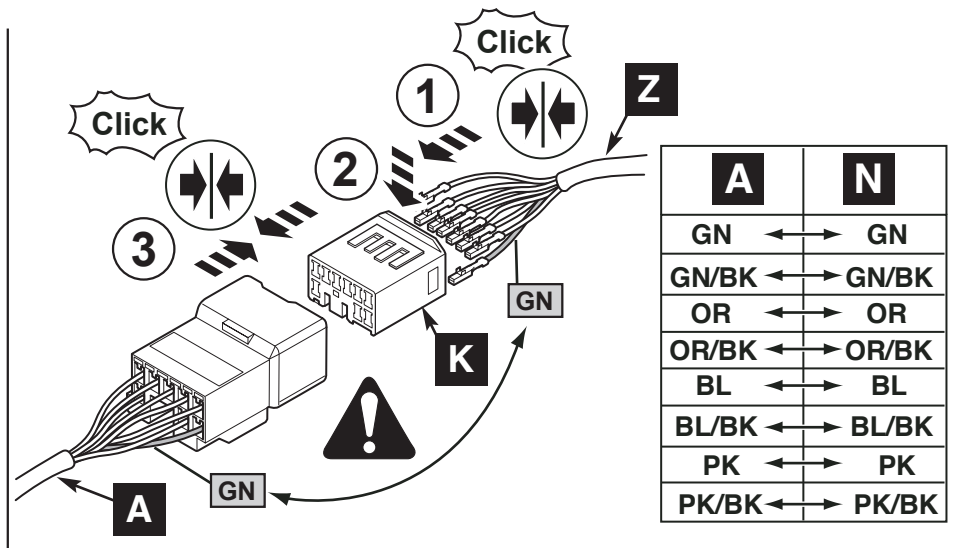



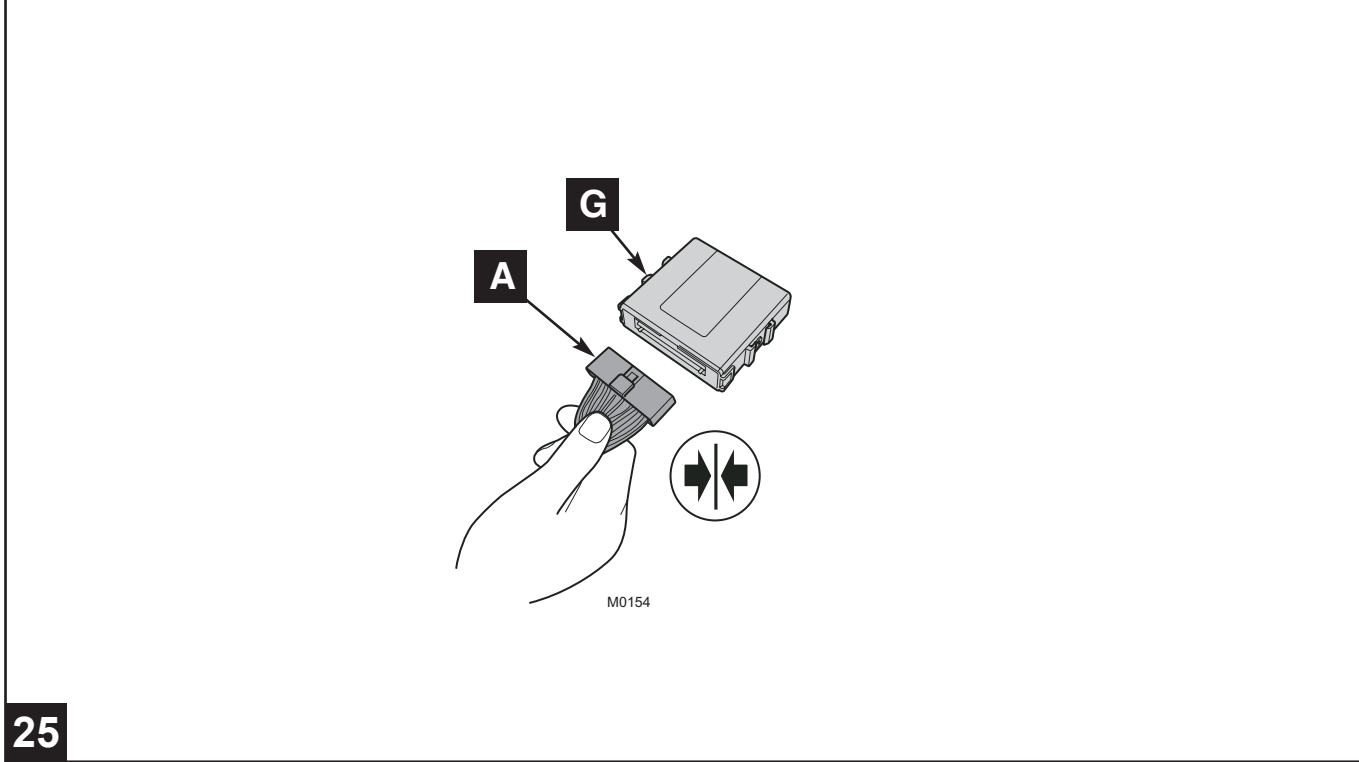
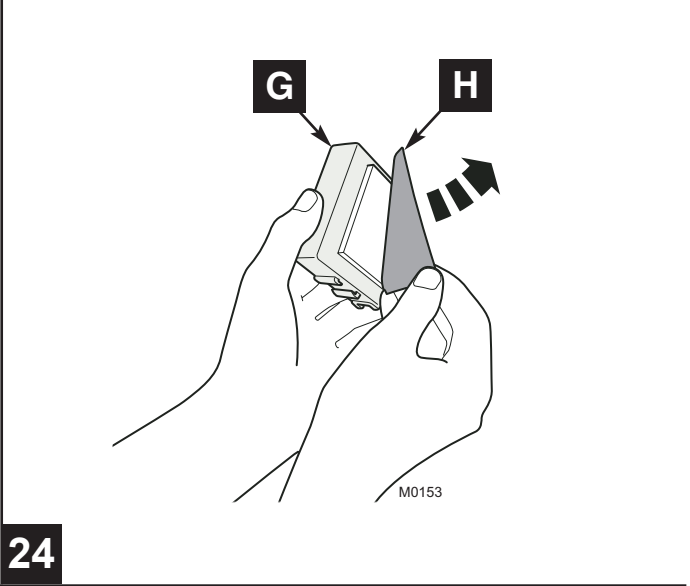
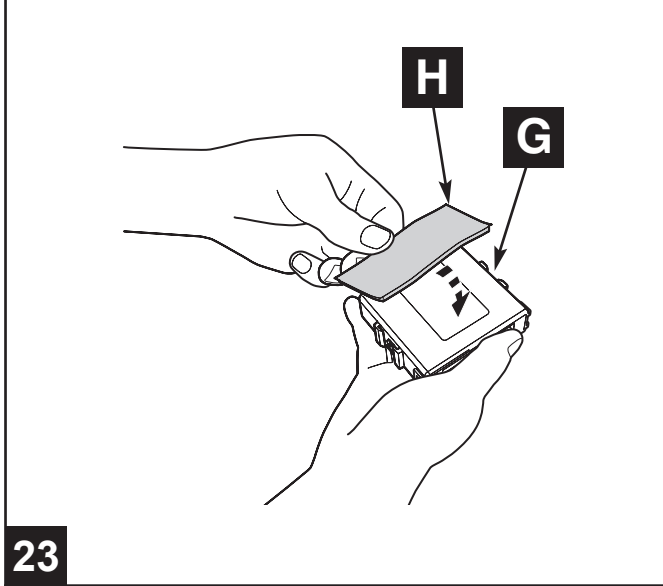
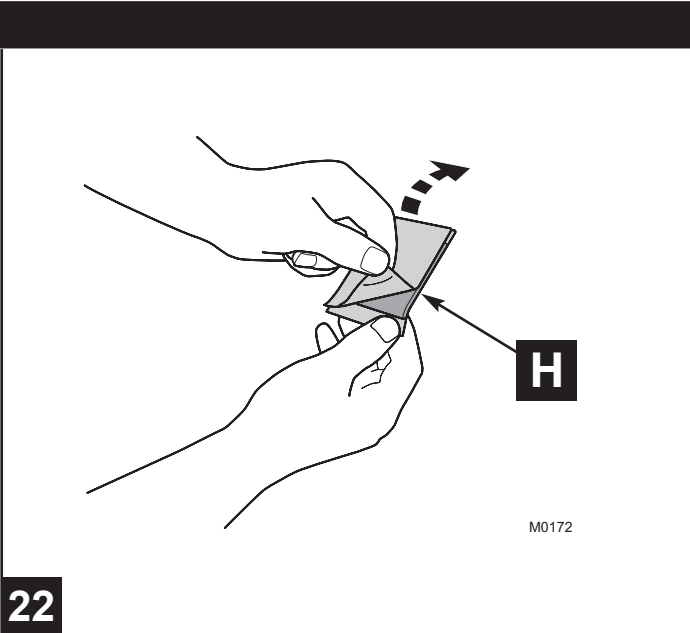
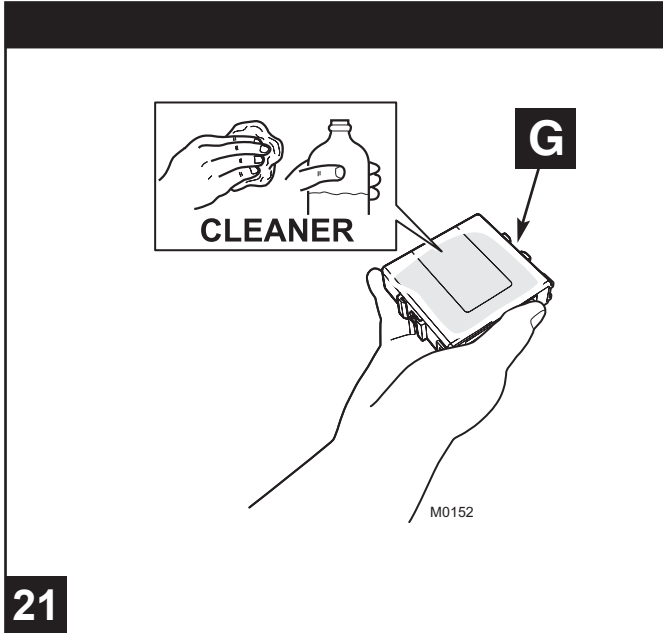

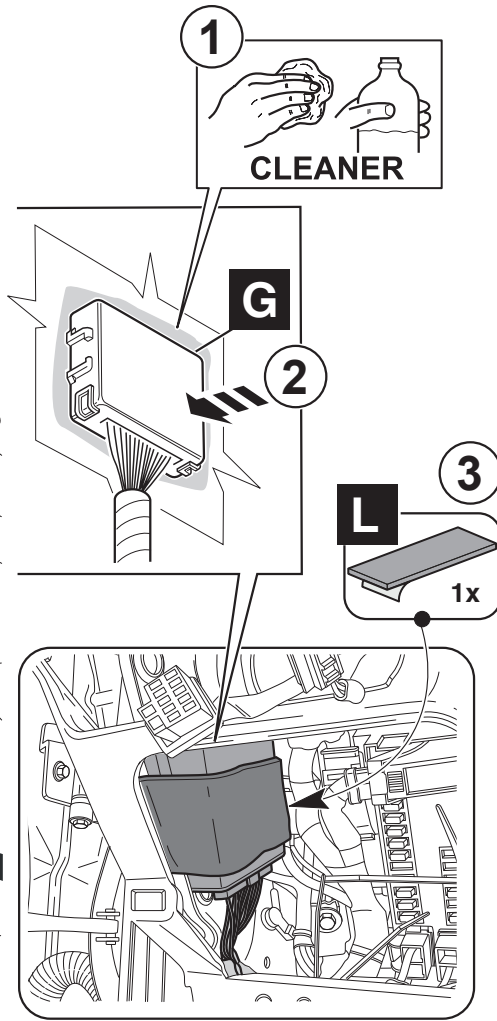
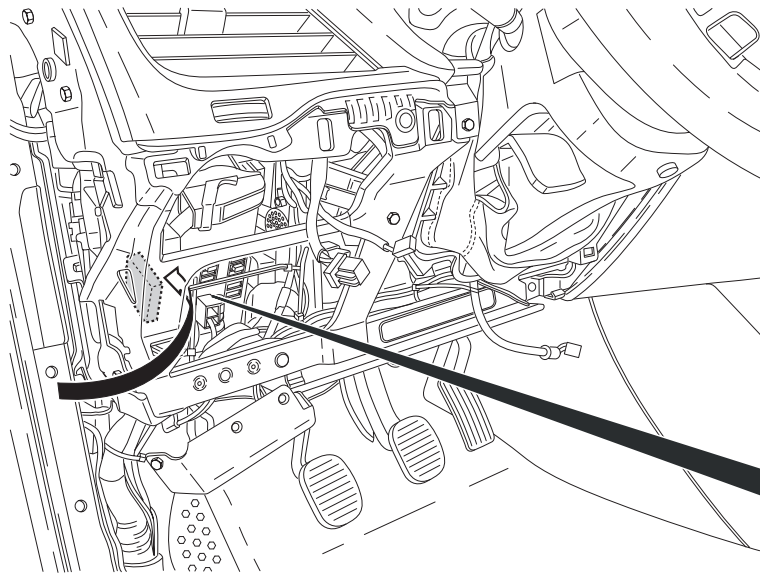
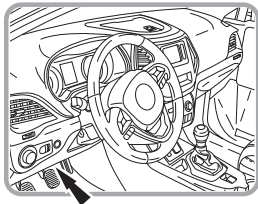

M0626

26

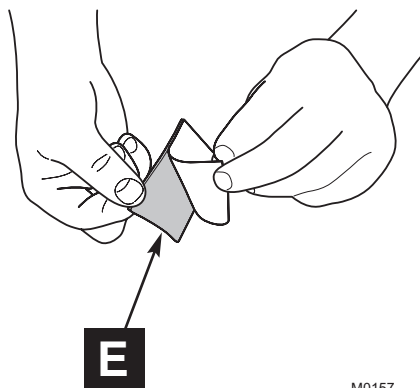

M0157

27

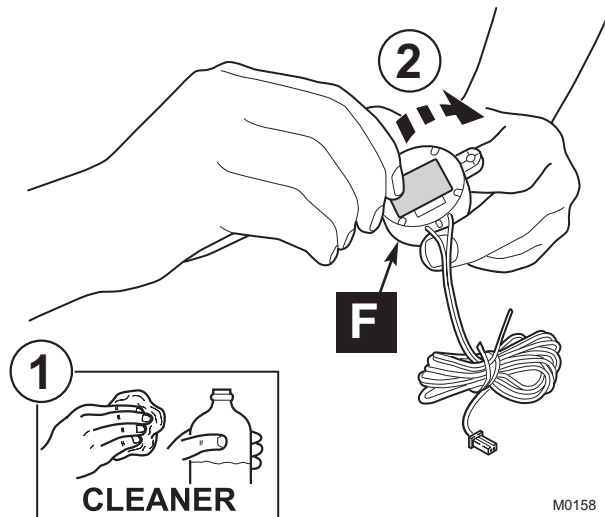

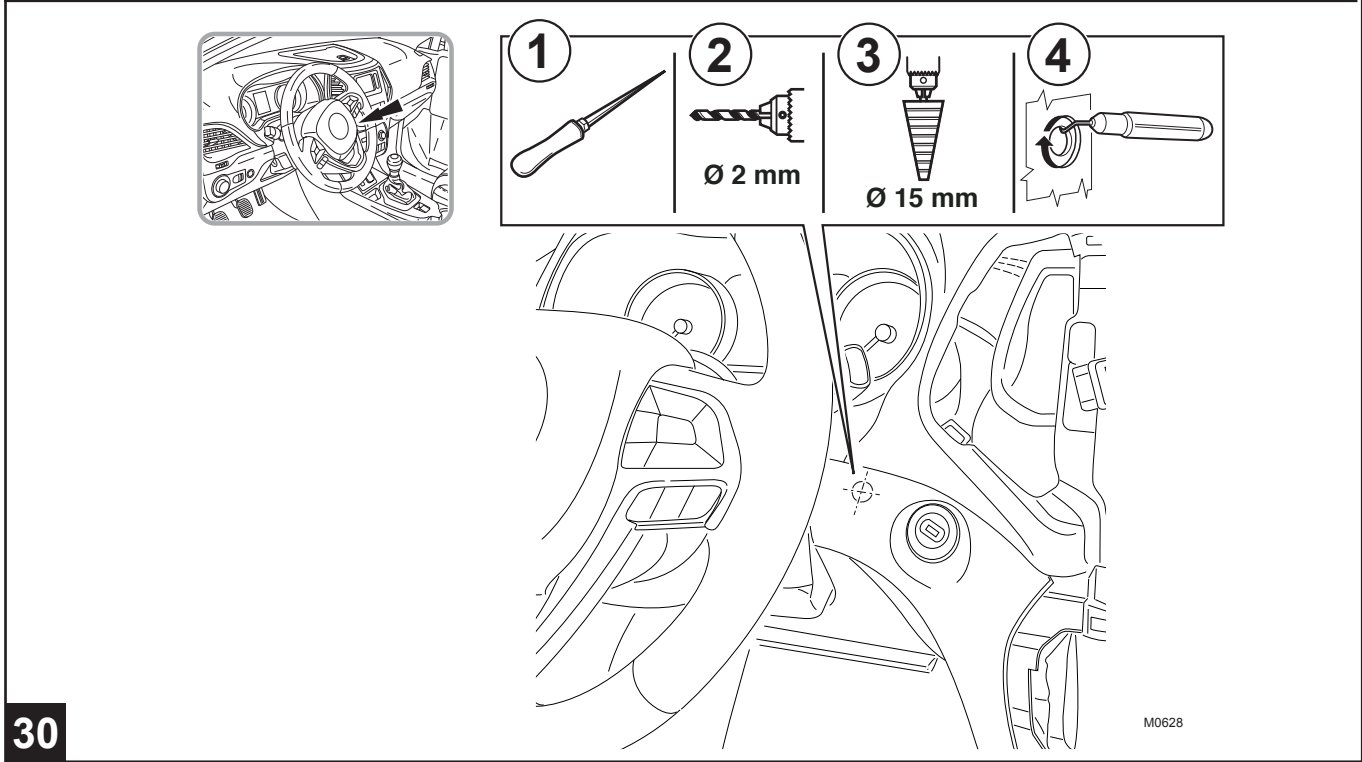
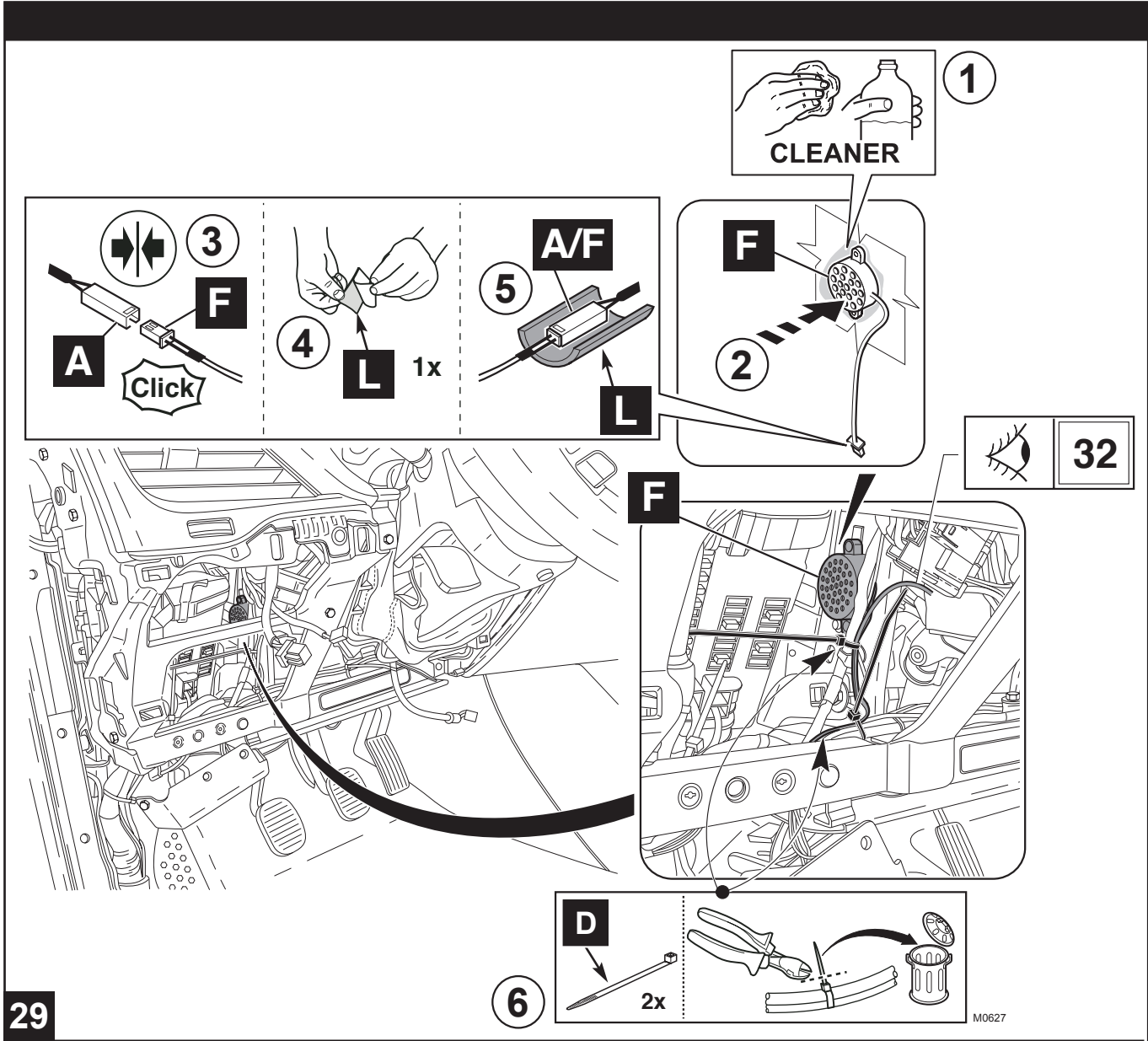

M0158

28

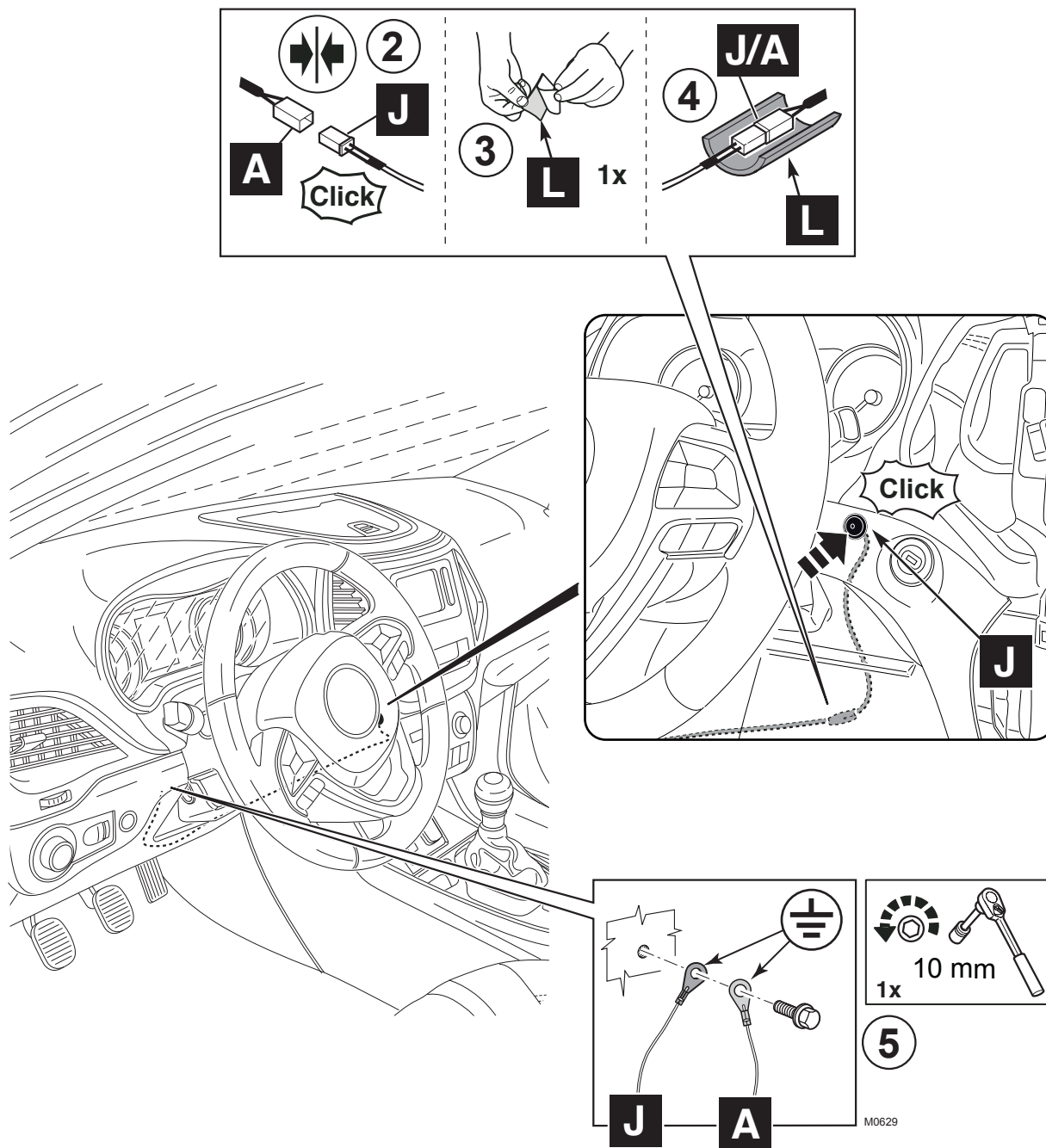

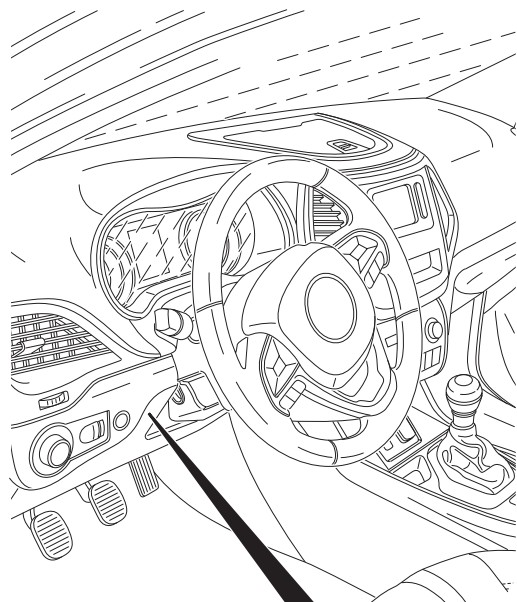







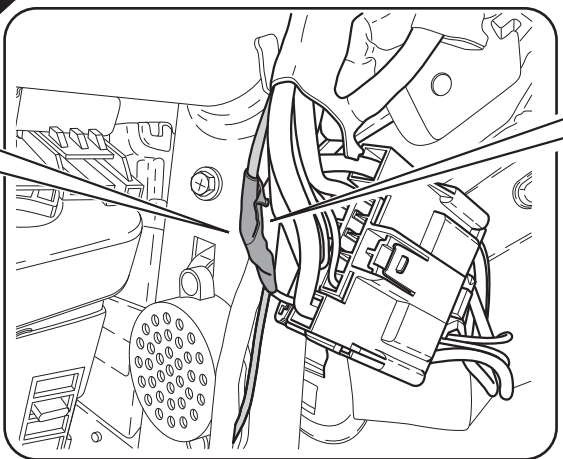

1  

2 **+15** 

3  

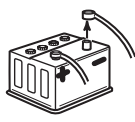

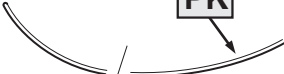

4   

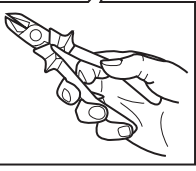
5  **PK**

6  **PK**

**GN/RD** 

**I**  

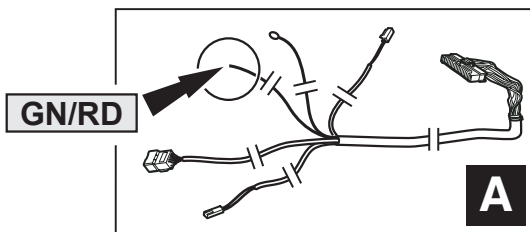

M0630

